

THE SEDUCTION OF MARBLE
IN LARGE SIZES

SUPREME

WIDE
SUPERSIZE SLABS



FLAVIKER

THE SEDUCTION OF MARBLE
IN LARGE SIZES

S U P R E M E

WIDE
SUPERSIZE SLABS

FLAVIKER

SUPREME



SUPREME PRESENTA SEI ORIGINALI VARIETÀ MARMOREE, DALLE PIÙ CLASSICHE A QUELLE PIÙ RARE E DECORATIVE PRODOTTE CON TECNOLOGIA CONTINUA+ CHE PERMETTE DI REALIZZARE LASTRE IN GRES PORCELLANATO ROBUSTE E LEGGERE FINO ALLA DIMENSIONE RECORD DI 160X320 CM.

SUPREME INTRODUCES SIX ORIGINAL MARBLE VARIETIES, FROM CLASSIC MARBLE TO RARER AND MORE DECORATIVE ONES, PRODUCED USING THE REVOLUTIONARY CONTINUA+ TECHNOLOGY, ABLE TO PRODUCE TOUGH YET LIGHTWEIGHT PORCELAIN SLABS WITH A RECORD SIZE OF 160X320 CM.

BLACK DELUXE

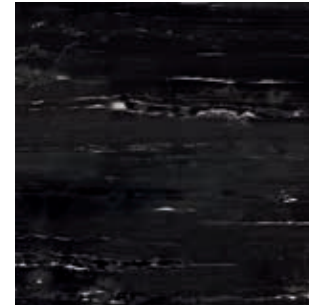

STATUARIO VENATO

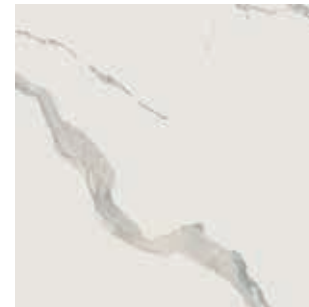

EXOTIC BROWN

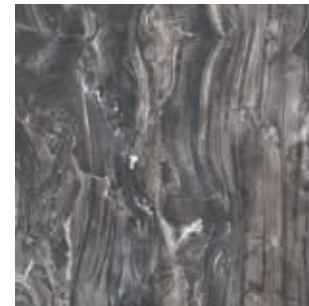

CALACATTA EXTRA



PURE STATUARIO

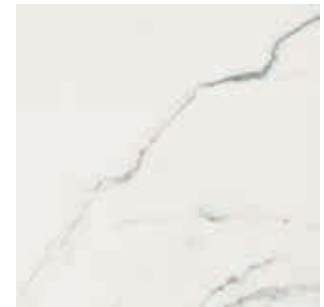

ONYX PRESTIGE



⌘ 6 mm

⌘ 7 mm

⌘ 9 mm

⌘ 12 mm

160x320

120x240

80x160

163,5x323

120x120

80x80

60x120

MULTIPLE SENSATIONS

MARMO, PIETRA, LEGNO E SUPERFICI
CHE RICHIAMANO I CEMENTI
INDUSTRIALI SI MESCOLANO TRA
LORO DANDO VITA A SITUAZIONI
ABITATIVE E COMMERCIALI UNICHE
E SORPRENDENTI.

MARBLE, STONE, WOOD AND SURFACES INSPIRED
BY INDUSTRIAL CONCRETE ARE MIXED
TO CREATE UNIQUE, VISUALLY-STRIKING
RESIDENTIAL AND COMMERCIAL SPACES.



SUPREME BLACK DELUXE



WALL: SUPREME BLACK DELUXE LUX+ 160X320
FLOOR: HANGAR SMOKE TRIANGOLO 30 | SUPREME PURE STATUARIO LUX+
160X160, TRIANGOLO 30 | SUPREME BLACK DELUXE LUX+ TRIANGOLO 30
VOLUME: HANGAR SMOKE 160X320





Kalcidisco

WALL: SUPREME CALACATTA EXTRA LUX+ 160X320
FLOOR: SUPREME BLACK DELUXE LUX+ 160X320

SUPREME CALACATTA EXTRA



WALL: SUPREME CALACATTA EXTRA LUX+ 120X240 |
STILL NO_W SAND 120X240
FLOOR: SUPREME CALACATTA EXTRA LUX+ 120X120





WALL: SUPREME CALACATTA EXTRA LUX+ 120X240 | STILL NO_W SAND 120X240
FLOOR: SUPREME CALACATTA EXTRA LUX+ 120X120

SUPREME STATUARIO VENATO



FLOOR: SUPREME STATUARIO VENATO LUX+ 120X120



WALL: SUPREME STATUARIO VENATO LUX+ 120X240

FLOOR: HANGAR ASH 120X120



WALL: SUPREME BOOK MATCH STATUARIO VENATO LUX+ 120X240 | HYPER SILVER 120X240

FLOOR: SUPREME STATUARIO VENATO LUX+ 120X120

SUPREME PURE STATUARIO



WALL: SUPREME PURE STATUARIO LUX+ 160X320 | HANGAR SMOKE 160X320
FLOOR: HANGAR SMOKE TRIANGOLO 30 | SUPREME PURE STATUARIO LUX+
160X160, TRIANGOLO 30 | SUPREME BLACK DELUXE LUX+ TRIANGOLO 30





FLOOR: SUPREME PURE STATUARIO RETT 80X80

SUPREME EXOTIC BROWN



TABLES: SUPREME EXOTIC BROWN LUX+ 160X320





WALL: SUPREME EXOTIC BROWN LUX+ 160X320 | STILL NO_W COAL 160X320
FLOOR: STILL NO_W COAL 160X320, TRIANGOLO 30



SUPREME ONYX PRESTIGE



WALL: SUPREME ONYX PRESTIGE LUX+ 120X240
FLOOR: COZY BROWN 26X200





FLOOR: SUPREME ONYX PRESTIGE LUX+ 120X120 | MATITA ALLUMINIO BRONZO 0,5X120

SUPREME

LASTRE IN GRES PORCELLANATO / PORCELAIN SLABS



BLACK DELUXE



6 mm	* 160x320	LUX+	0000401
7 mm	120x240	LUX+	0000407
	120x120	LUX+	0000410
	60x120	LUX+	0000935

* Fino ad esaurimento scorte l'art. verrà consegnato a spessore 7 mm.
The item will be delivered 7 mm thick until stocks are exhausted.

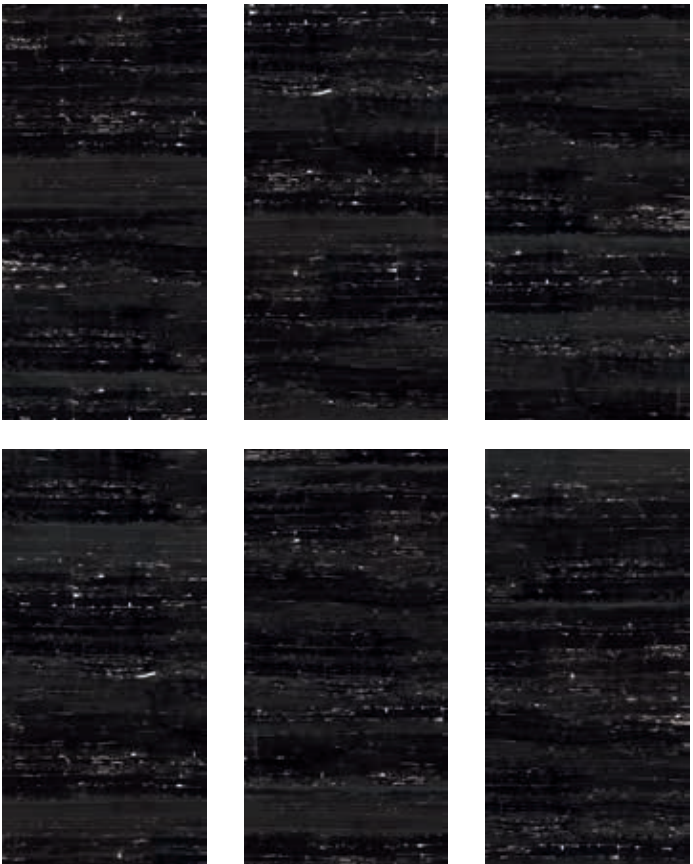

CALACATTA EXTRA



✂ 6 mm	*160x320	LUX+	0000367
	*160x320	RETT.	0002751
✂ 7 mm	120x240	LUX+	0000379
	120x120	LUX+	0000385
✂ 9 mm	*80x160	RETT.	0000732
	*80x80	LUX+	0000717
	*80x80	RETT.	0000736

* Fino ad esaurimento scorte l'art. verrà consegnato a spessore 7 mm.
The item will be delivered 7 mm thick until stocks are exhausted.

Disponibile anche | Available also

CALACATTA EXTRA

✂ 12 mm	163,5x323	SOFT
✂ 12 mm	163,5x323	LUX
✂ 20 mm	163,5x323	SOFT
✂ 20 mm	163,5x323	LUX

MATERIA.



STATUARIO VENATO



✂ 6 mm	*160x320	LUX+	0002481
	*160x320	RETT.	0002756
✂ 7 mm	120x240	LUX+	0002497
	120x120	LUX+	0002510
	60x120	LUX+	0002513

* Fino ad esaurimento scorte l'art. verrà consegnato a spessore 7 mm.
The item will be delivered 7 mm thick until stocks are exhausted.



PURE STATUARIO



⊗ 6 mm	*160x320	LUX+	0000371
⊗ 7 mm	120x240	LUX+	0000383
	120x120	LUX+	0000389
⊗ 9 mm	*80x160	RETT.	0000735
	*80x80	LUX+	0000718
	*80x80	RETT.	0000739

* Fino ad esaurimento scorte l'art. verrà consegnato a spessore 7 mm.
The item will be delivered 7 mm thick until stocks are exhausted.



EXOTIC BROWN



⊗ 6 mm	*160x320	LUX+	0000399
⊗ 7 mm	120x240	LUX+	0000405
	120x120	LUX+	0000408

* Fino ad esaurimento scorte l'art. verrà consegnato a spessore 7 mm.
The item will be delivered 7 mm thick until stocks are exhausted.

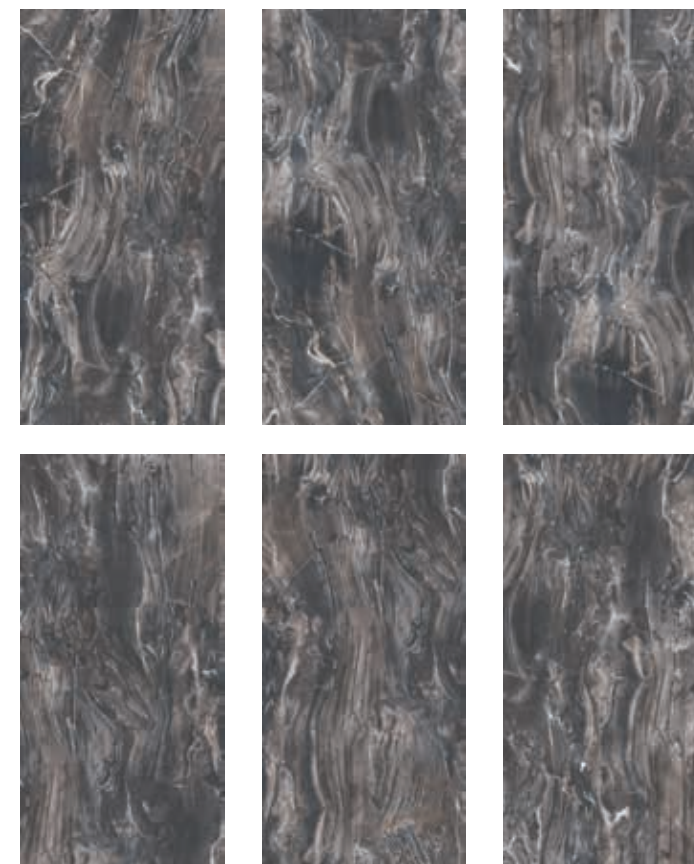

SUPREME

LASTRE IN GRES PORCELLANATO / PORCELAIN SLABS

ONYX PRESTIGE



120 x 120

± 6 mm	*160x320	LUX+	0000400
± 7 mm	120x240	LUX+	0000406
	120x120	LUX+	0000409

* Fino ad esaurimento scorte l'art. verrà consegnato a spessore 7 mm.
The item will be delivered 7 mm thick until stocks are exhausted.



SUPREME

WIDE
SUPER SIZE SLABS

BOOK MATCH CALACATTA EXTRA

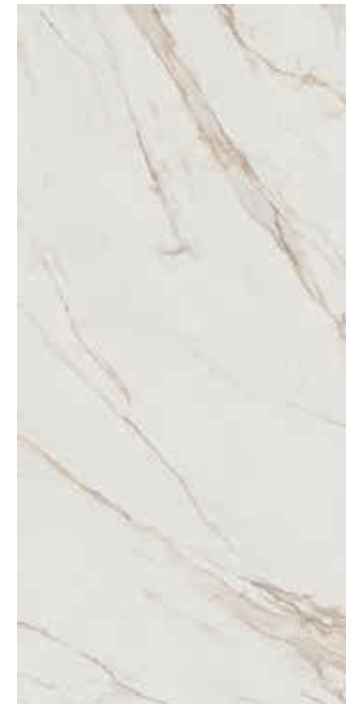

SLAB A

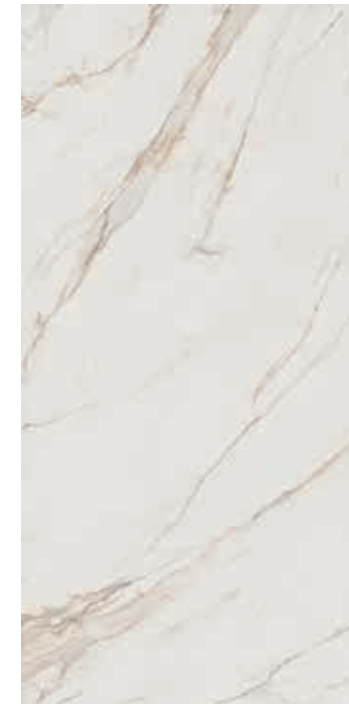

SLAB B

± 7 mm	SLAB A	120x240	LUX+	0001127
	SLAB B	120x240	LUX+	0001128

BOOK MATCH STATUARIO VENATO

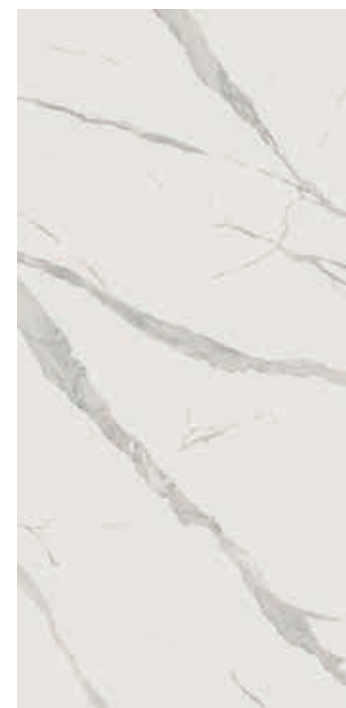

SLAB A



SLAB B

± 7 mm	SLAB A	120x240	LUX+	0002500
	SLAB B	120x240	LUX+	0002501

Ripresa grafica tra le diverse lastre contenuta entro una tolleranza di 3 cm.
Graphic clearance among the different slabs ranging within 3 cm.

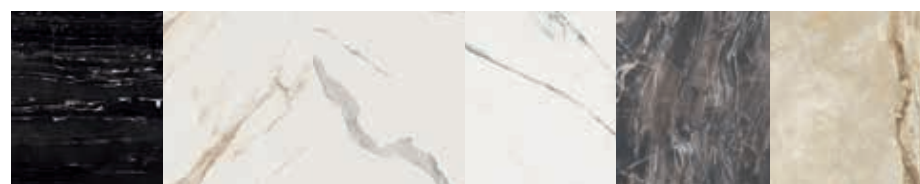

BLACK DELUXE CALACATTA EXTRA STATUARIO VENATO PURE STATUARIO EXOTIC BROWN ONYX PRESTIGE

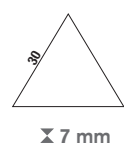

Triangolo 30 14 = 0,54 mq	LUX+ RETT.	0000415	0000412	-	0000413	0000411	0000414
------------------------------	---------------	---------	---------	---	---------	---------	---------

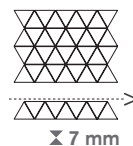

Mos. Triangoli 34x26 5	LUX+	0000998	0000995	-	0000996	0000994	0000997
------------------------------	------	---------	---------	---	---------	---------	---------

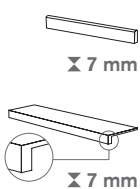

Battiscopa 5,5x120 6	LUX+ RETT.	0000938	0000867	0002518	0000871	0000936	0000937
----------------------------	---------------	---------	---------	---------	---------	---------	---------

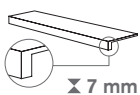

Gradone Plus 32x120x4,5x1,5 1	LUX+ RETT.	0000941	0000873	0002521	0000877	0000939	0000940
-------------------------------------	---------------	---------	---------	---------	---------	---------	---------

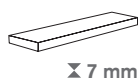

Angolare Plus Sx 32x120x4,5x1,5 1	LUX+ RETT.	0000944	0000879	0002524	0000883	0000942	0000943
---	---------------	---------	---------	---------	---------	---------	---------

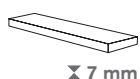

Angolare Plus Dx 32x120x4,5x1,5 1	LUX+ RETT.	0000947	0000885	0002527	0000889	0000945	0000946
---	---------------	---------	---------	---------	---------	---------	---------

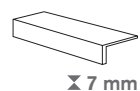

Gradone Jolly 40x120x20 1	LUX+ RETT.	0004552	0004549	0004555	0004550	0004548	0004551
---------------------------------	---------------	---------	---------	---------	---------	---------	---------

0,5x120	0000086	MATITTA ALLUMINIO	4
0,5x120	0000087	MATITTA ALLUMINIO WHITE	4
0,5x120	0000088	MATITTA ALLUMINIO BLACK	4

0,5x120	0000556	MATITTA ALLUMINIO RAME	4
0,5x120	0000557	MATITTA ALLUMINIO BRONZO	4

Articoli realizzati in alluminio per l'uso a parete, adatti a raccordare piastrelle di diverso spessore (9 mm / 7 mm).
Aluminium strip for use between wall tiles of different thicknesses (9 mm / 7 mm).

TRIANGOLO 30

01.1 2 colori

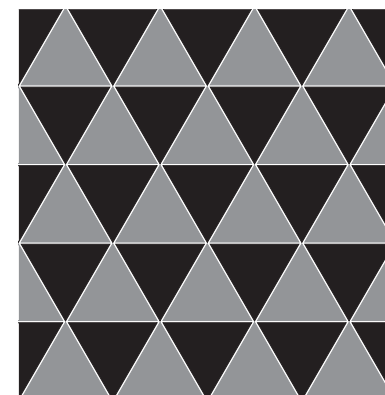

COLOR 1 50% ■
COLOR 2 50% ■

01.2 2 colori

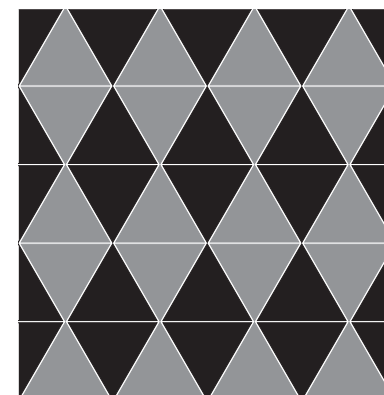

COLOR 1 50% ■
COLOR 2 50% ■

01.3 2 colori

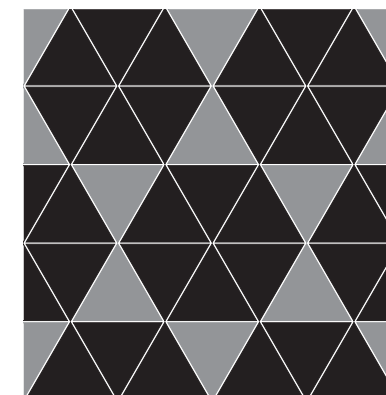

COLOR 1 75% ■
COLOR 2 25% ■

01.4 2 colori

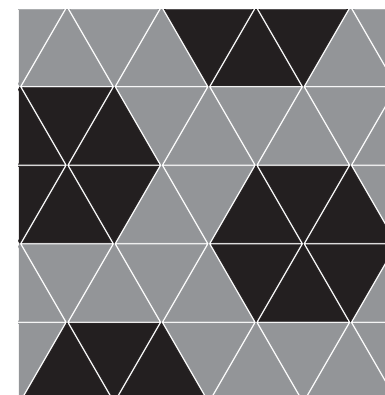

COLOR 1 57% ■
COLOR 2 43% ■

01.5 3 colori

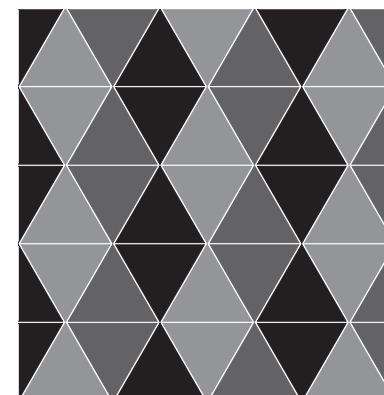

COLOR 1 33,33% ■ COLOR 3 33,33% ■
COLOR 2 33,33% ■

01.6 3 colori

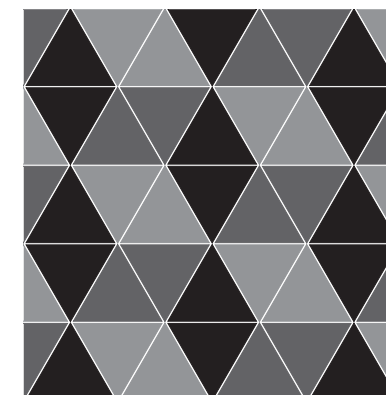

COLOR 1 33,33% ■ COLOR 3 33,33% ■
COLOR 2 33,33% ■

01.7 3 colori

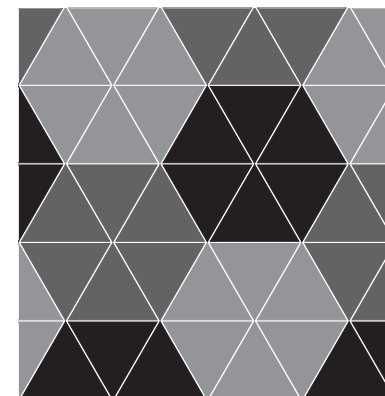

COLOR 1 33,33% ■ COLOR 3 33,33% ■
COLOR 2 33,33% ■

01.8 4 colori

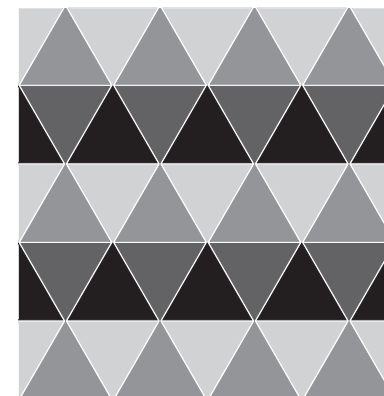

COLOR 1 25% ■ COLOR 3 25% ■
COLOR 2 25% ■ COLOR 4 25% ■

02 2 colori

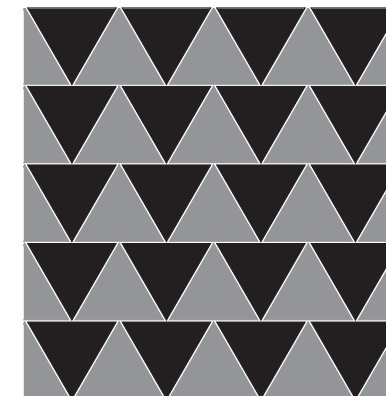

COLOR 1 50% ■
COLOR 2 50% ■



ESEMPIO DI REALIZZAZIONE ON DEMAND
 EXAMPLE OF ON DEMAND SERVICE REALIZATION
 WALL: SUPREME THREE ON DEMAND BLACK DELUXE LUX+
 FLOOR: STILL NOW SAND 120X120

COMPOSIZIONI DECORATIVE / DECORATIVE COMPOSITIONS

Con un occhio attento alla decorazione di interni, FLAVIKER propone composizioni grafiche realizzate a idrogetto sulle lastre ceramiche in 7 mm. Le fughe, se esaltate con stucchi a contrasto, diventano motivo decorativo. Questi soggetti sono disponibili nel formato 120x240 cm, oppure adattabili a qualsiasi misura richiesta con il servizio ON DEMAND. Il cliente dovrà fornire le esatte dimensioni della superficie da rivestire; verrà poi realizzato un disegno esecutivo con relativo preventivo. Ogni singolo pezzo che compone il soggetto verrà numerato in modo da facilitare le operazioni di posa. Fuga tra i diversi pezzi 2 mm.

With a keen eye for interior decoration, FLAVIKER offers design compositions created from waterjet-cut 7 mm thick ceramic slabs. Contrasting coloured grout can be used to enhance the joints and create a decorative pattern. These designs are available in 120x240 cm slabs or can be adapted to surfaces of any size using the ON DEMAND service. The customer will need to provide the exact dimensions of the surface to be tiled, after which a detailed drawing and quote can be made. Each piece making up the design will be numbered for ease of installation. A 2 mm joint will be maintained between the individual tiles.

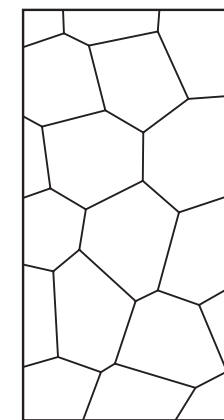

PEBBLE
 COMP. 120x240

EXOTIC BROWN LUX+	0000987
BLACK DELUXE LUX+	0000991
PURE STATUARIO LUX+	0000989
ONYX PRESTIGE LUX+	0000990
CALACATTA EXTRA LUX+	0000988
STATUARIO VENATO LUX+	0003546

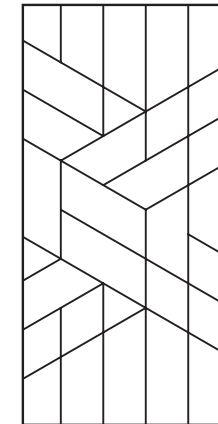

TETRIS
 COMP. 120x240

EXOTIC BROWN LUX+	0000982
BLACK DELUXE LUX+	0000986
PURE STATUARIO LUX+	0000984
ONYX PRESTIGE LUX+	0000985
CALACATTA EXTRA LUX+	0000983
STATUARIO VENATO LUX+	0003643

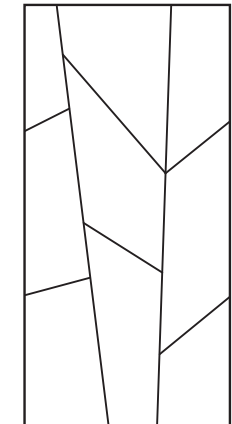

THREE
 COMP. 120x240

EXOTIC BROWN LUX+	0000977
BLACK DELUXE LUX+	0000981
PURE STATUARIO LUX+	0000979
ONYX PRESTIGE LUX+	0000980
CALACATTA EXTRA LUX+	0000978
STATUARIO VENATO LUX+	0003640

COD. PER IL SERVIZIO SU MISURA ON DEMAND / ON DEMAND SERVICE CODE: 0000100

Indicare le esatte dimensioni della parete da rivestire e i colori con cui realizzare la composizione.
 Indicate the exact sizes of the wall to be tiled and the colours to use for the composition.

ESEMPI DI APPLICAZIONE / EXAMPLES OF APPLICATION

COMP. 120X240

Consigliata per posa a pezzo singolo
 Recommended for single-piece installation

Altezza soffitto 400 cm, Altezza posa 240 cm

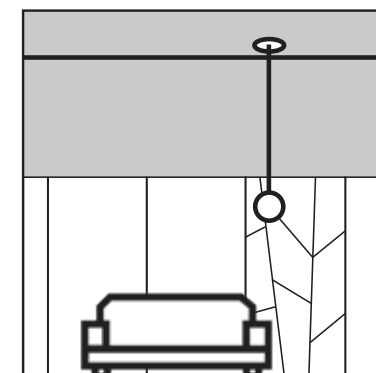

ON DEMAND

Es. Posa alt. 240 cm in tutta la parete
 Ex. Laying 240 cm height throughout the length of the wall

Altezza soffitto 400 cm, Altezza posa 240 cm

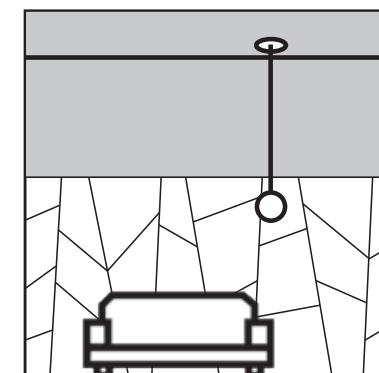

ON DEMAND

Es. Posa a tutta parete
 Ex. Laying full height tiles

Altezza soffitto 400 cm, Altezza posa 400 cm

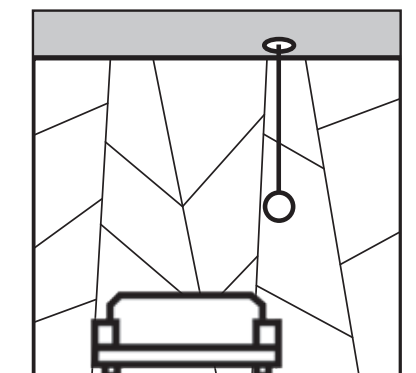

CERAMIC R-EVOLUTION

Il progetto WIDE Flaviker parte dalla rivoluzionaria tecnologia produttiva CONTINUA+, che permette di produrre lastre in gres porcellanato robuste e leggere allo stesso tempo, grazie allo spessore ridotto di 6 e 7 mm, fino alla dimensione record di 160x320 cm. Il nuovo sistema di pressatura prevede la compattazione a secco delle materie prime e consente di ottenere superfici particolarmente apprezzabili sia per la qualità estetica che per le performance tecniche.

Flaviker's WIDE collection consists of tough yet lightweight porcelain slabs with a thickness of just 6 and 7 mm and a record size of 160x320 cm produced using the revolutionary CONTINUA+ technology. The new pressing system involves dry compaction of raw materials and is able to produce surfaces that combine excellent aesthetic quality with outstanding technical performance.



WIDE & STRONG

WIDE è perfettamente idoneo sia per il rivestimento che per la pavimentazione, in ambito residenziale e commerciale. Gli spessori 6 e 7 mm consentono di mantenere un'ottima resistenza al carico di rottura reale.

WIDE is ideal as both a floor and wall covering in residential and commercial projects. The 6 and 7 mm thicknesses enable it to maintain excellent breaking strength in real situations.

PESO WEIGHT

FLAVIKER 9 mm = 19,5 Kg x mq
FLAVIKER 7 mm = 17,5 Kg x mq
FLAVIKER 6 mm = 15,0 Kg x mq



LITE GOES WIDE

Gli spessori 6 e 7 mm consentono di ridurre il peso per mq con interessanti vantaggi in termini di maneggevolezza e movimentazione.

The 6 and 7 mm thicknesses result in a reduced weight per square metre, bringing significant advantages in terms of ease of working and handling.



WIDE IS LEVELING

La combinazione fra impasto ad elevata plasticità, spessore e grande dimensione, dona particolare elasticità al prodotto, per ottenere risultati di posa sempre impeccabili.

The combination of a body with high plasticity, thickness and dimensions makes for a highly elastic product that delivers consistently flawless results.



EASY AS WIDE

La formulazione dell'impasto, unita alla compattazione a secco e alla cottura in forni di nuova concezione, genera un gres particolarmente facile da tagliare e lavorare.

The chemical formulation of the body combined with the raw material dry compaction process produces a porcelain slab that is easy to cut and work with.



WIDE MEANS GREEN

L'impasto contiene il 40% minimo di materie prime di qualità recuperate da altri processi produttivi, per questo i prodotti WIDE possono essere accreditati all'interno del sistema internazionale LEED.

As the body contains a minimum of 40% high-quality raw materials recycled from other production processes, WIDE collection products qualify for LEED international certification.

indicatore di flessibilità flexibility index	deflessione massima sotto carico di 350 N maximum deflection under load of 350 N	lato/length 2400 mm	> 50 mm
		lato/length 2700 mm	> 70 mm
		lato/length 3200 mm	> 100 mm

NEW DIMENSIONS

Uno degli obiettivi del progetto WIDE è quello di fornire un materiale ceramico tecnologicamente avanzato facilmente utilizzabile in contesti anche molto diversi, per dimensione e per destinazione d'uso. WIDE è un vero e proprio programma di formati, tutti rettificati, pensati per coprire a 360° le esigenze legate alla progettazione, a partire dagli spazi residenziali, fino alle grandi opere in ambito pubblico e commerciale.

One of the aims of the WIDE project is to supply a hi-tech ceramic material that is easy to use in very different sizes and applications. WIDE comes in a large selection of sizes, all rectified, ideal for uses ranging from residential through to large-scale works in public and commercial spaces.

EVERYWHERE YOU LIKE

Tenendo conto delle principali qualità del materiale, tra cui la robustezza, la resistenza agli sbalzi termici, oltre allo spessore contenuto e alla facilità di lavorazione, le grandi lastre WIDE ampliano la destinazione d'uso del gres porcellanato. Sempre meno fughe e sempre più spazio alla creatività di progettisti e interior designers, che grazie ai prodotti WIDE possono apprezzare la versatilità di una ceramica senza più confini.

Taking account of the material's key qualities, including strength, thermal shock resistance, low thickness and ease of working, the WIDE large-format slabs extend the fields of use of porcelain. The WIDE collection has fewer joints while giving enormous creative freedom to architects and interior designers, who appreciate the versatility of this ceramic surface without limits.



PAVIMENTI INTERNI
INDOOR FLOORS



RIVESTIMENTI INTERNI
INDOOR WALLS

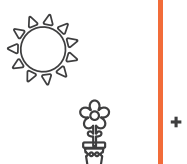

FACCIADE ESTERNE
INCOLLATE E VENTILATE
GLUED AND VENTILATED
EXTERIOR FAÇADES

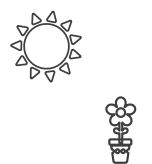

PAVIMENTI AREE ESTERNE
OUTDOOR FLOORS



PIANI LAVORO CUCINE
KITCHEN COUNTERTOPS



TOP E FINITURE PER AMBIENTI
BAGNO
BATHROOM VANITY TOPS AND
SHELVS



ELEMENTI DI ARREDO E DESIGN
PER INTERNI
INTERIOR FURNISHING AND
DESIGN ELEMENTS

SUPREME

F.to nominale Nominal size	F.to reale (mm) Work size (mm)	Spessore Thickness	Tipologia imballo Type of packing	Lastre/Imballo Slabs/Packing	Pz/Imballo Pcs/Packing	Mq/Scatola Sqm/Box	Kg/Scatola Kg/Box	Scatole/Imballo Box/Packing	Mq totali Sqm total	Kg/Imballo Kg/Packing	Kg totali Kg total
163,5x323 / 65.2"x129.2" nat	1635x3230	12 mm	Cassa Crate	10	-	-	-	-	51,20	139	1.660
163,5x323 / 65.2"x129.2" lux+	1635x3230	12 mm	Cassa Crate	9	-	-	-	-	46,08	139	1.508
163,5x323 65.2"x129.2" nat/lux+	1635x3230	12 mm	Cavalletto container legno A - frame	22	-	-	-	-	112,64	180	3.524
			Container Rack pallet wood A - frame								
163,5x323 / 65.2"x129.2" nat/lux+	1635x3230	12 mm	Cavalletto container metallo A - frame	22	-	-	-	-	112,64	180	3.524
			Container Rack pallet metal A - frame								
160x320 / 64"x128" rett./lux+	1596,5x3195	6 mm	Cassa Crate	14	-	-	-	-	71,68	139	1.214
			Cavalletto container Container Rack pallet	36	-	-	-	-	184,32	180	2.945
120x240 / 48"x96" lux+	1194x2390	7 mm	Cassa Crate	20	-	-	-	-	57,60	100	1.108
			Cavalletto Rack pallet	40	-	-	-	-	115,20	100	2.116
			Cavalletto container Container Rack pallet	40	-	-	-	-	115,20	115	2.131
80x160 / 32"x64" lux+	797,25x1596,5	9 mm	Cavalletto Rack pallet	44	2	2,56	50,00	22	56,32	70	1.170
			Pallet con sponde Pallet with sides	44	2	2,56	50,00	22	56,32	40	1.140
120x120 / 48"x48" lux+	1194x1194	7 mm	Pallet con sponde Pallet with sides	44	2	2,88	50,40	22	63,36	40	1.149
60x120 / 24"x48" lux+	596x1194	7 mm	Pallet	81	3	2,16	37,80	27	58,32	20	1.041
80x80 / 32"x32" rett./lux+	797,25x797,25	9 mm	Pallet	88	2	1,28	25,00	44	56,32	20	1.120

I pezzi speciali, per effetto delle lavorazioni, possono presentare variazioni di tonalità. Due to working process, special trims may show variations in tonality.

L'unità minima di vendita per tutti gli articoli (fondi, decori e pezzi speciali) è la scatola completa. The minimum sales quantity for all items (plain tiles, decorations and special trims) is one full box.

I dati relativi agli imballi sono aggiornati al momento della stampa del catalogo e pertanto possono subire variazioni nel corso del tempo. Data referring to packaging have been update at time of printing; the actual data may be slightly different.

LASTRE IN GRES PORCELLANATO PORCELAIN SLABS

CLASSIFICAZIONE SECONDO NORME UNI EN 14411 (ISO 13006) ALLEGATO G-Gruppo Bia
CLASSIFICATION IN ACCORDANCE WITH UNI EN 14411 (ISO 13006) ANNEX G-Group Bia

PROPRIETÀ FISICO-CHIMICHE PHYSICAL-CHEMICAL PROPERTIES	NORMA NORM	VALORE PRESCRITTO DALLE NORME VALUE PRESCRIBED FROM THE NORMS	VALORE NATURALE NATURAL VALUE
RESISTENZA ALLO SCIVOLOAMENTO SLIP RESISTANCE	B.C.R.A. C.A.	μ 0,19 SCIVOLOSITÀ PERICOLOSA - DANGEROUSLY SLIPPERY $0,20 < \mu < 0,39$ SCIVOLOSITÀ ECCESSIVA - EXCESSIVELY SLIPPERY $0,40 < \mu < 0,74$ ATTRITO SODDISFACENTE - SATISFACTORY GRIP μ 0,75 ATTRITO ECCELLENTE - EXCELLENT GRIP	>0,40
	B.C.R.A. G.B.		
RESISTENZA ALLO SCIVOLOAMENTO SLIP RESISTANCE	ASTM C 1028 (S.C.O.F.)	SLIP RESISTANT (> 0,60)	>0,60 DRY >0,60 WET
	DIN 51130	IN FUNZIONE DELL'AMBIENTE O DELLA ZONA DI LAVORO BASING ON THE ENVIRONMENT OR THE WORKING AREA	R9

VARIAZIONE CROMATICA SHADE VARIATION	V3	aspetto uniforme uniform appearance V1	lieve variazione slight variation V2	moderata variazione moderate variation V3	forte variazione substantial variation V4
---	-----------	--	--	---	---

FLAVIKER-PI.SA
BRAND OF ABK GROUP INDUSTRIE CERAMICHE S.P.A.
S.S. 569 per Vignola, 226
41014 Solignano di Castelvetro (MO) Italy
T +39 (0) 59 9752011
F +39 (0) 59 9752010

flavikerpisa.it
#flaviker



La riproduzione dei colori è approssimativa.
Colour reproduction approximate.



19.9 Ceramics of Italy

FLAVIKER